

veritas[®]
Detail Palm Planes

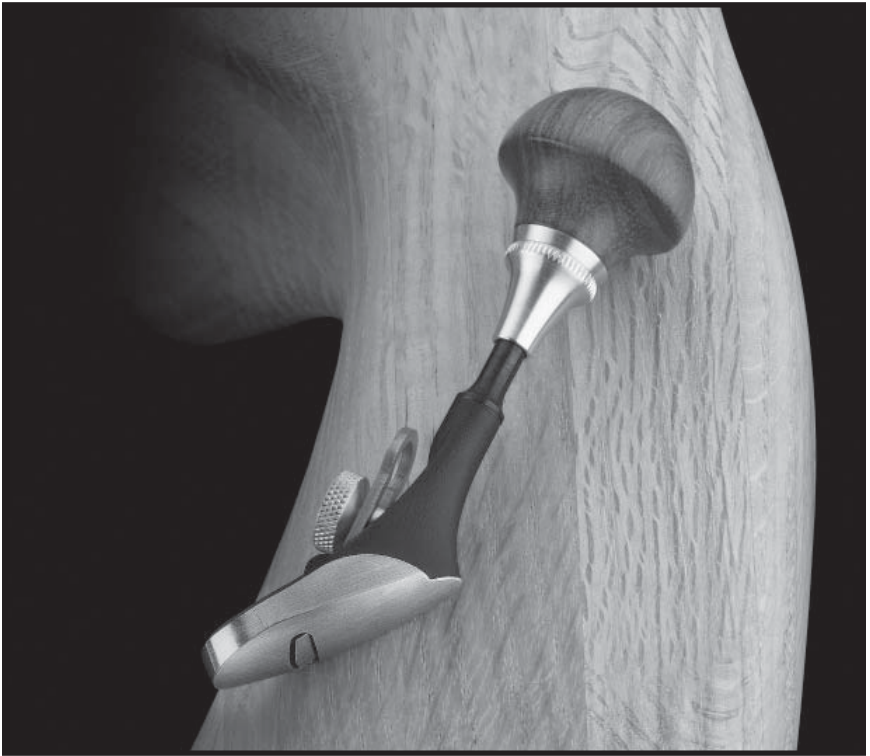

Patent Pending

The Veritas® Detail Palm Planes are ideal for working on small projects, as well as on the final details of larger workpieces. With bodies just over $\frac{5}{8}$ " wide and $1\frac{1}{2}$ " long and blades $\frac{3}{8}$ " wide, they are small enough to get into tight spaces and allow fine control for working details. Each plane has a $1\frac{1}{4}$ " diameter palm knob mounted on a detachable stem. The length of the stem may also be adjusted for improved control and comfort to best suit the task at hand.

Available in four versions: flat, double convex, convex, and concave. The curved versions have a $\frac{1}{2}$ " radius across the body, and the double convex is curved with a 4" radius along its length.

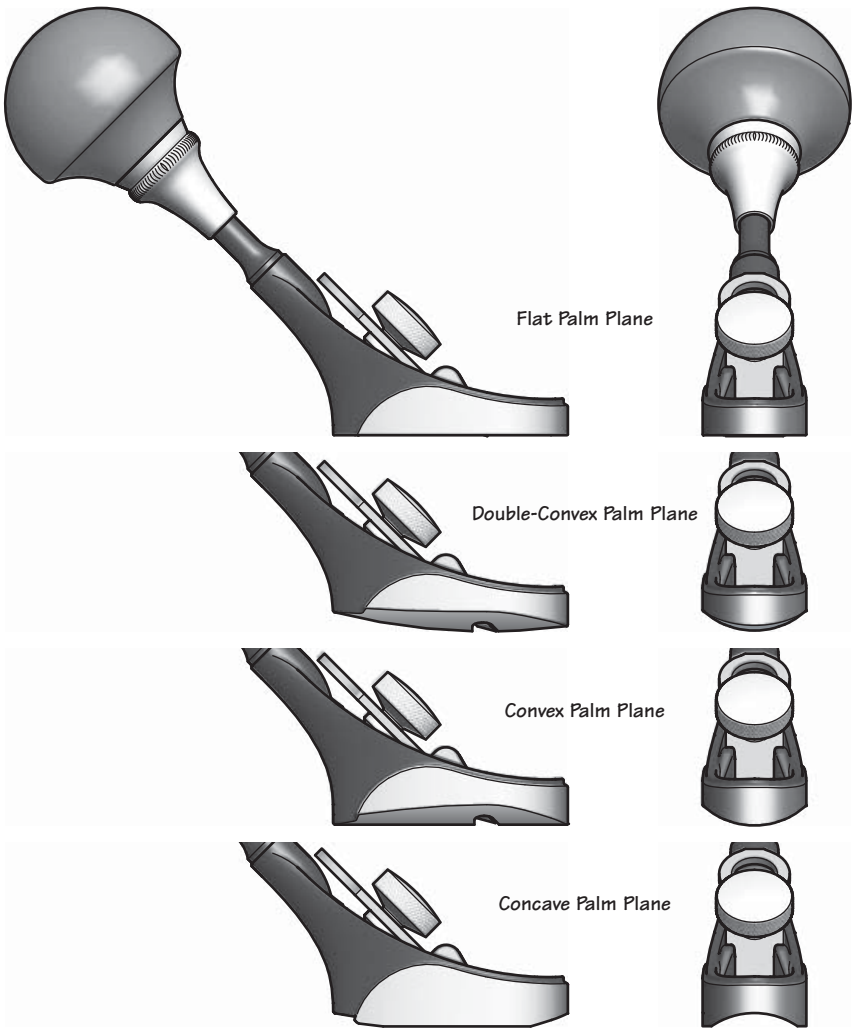

Figure 1: View of all four detail palm planes.

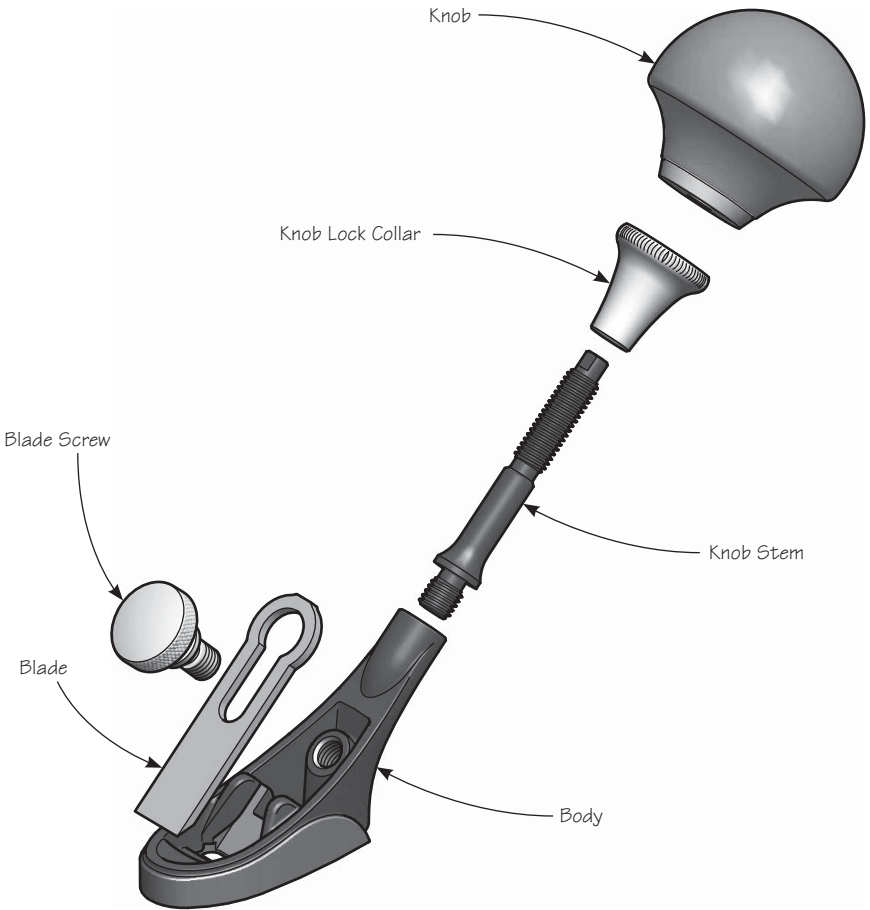

Figure 2: Detail palm plane parts.

Blade Adjustment

⚠ Caution: *Blade is sharp. The sides and top edges of the blade have been lightly deburred after lapping. Depending on how you grip the plane, you may find these edges uncomfortable. If desired, you can round over the square edges with a file.*

To initially set the blade, place the plane on a piece of wood that matches the sole contour (e.g., a scrap of stock) and slide the blade (bevel down) under the fixed ribs until it just touches the wood. As you tighten the blade screw against the blade to secure the blade, the shoulder of the screw will pull the blade up to jam it against the fixed ribs.

Note: *The screw has a left-hand thread, so turning it clockwise will secure the blade.*

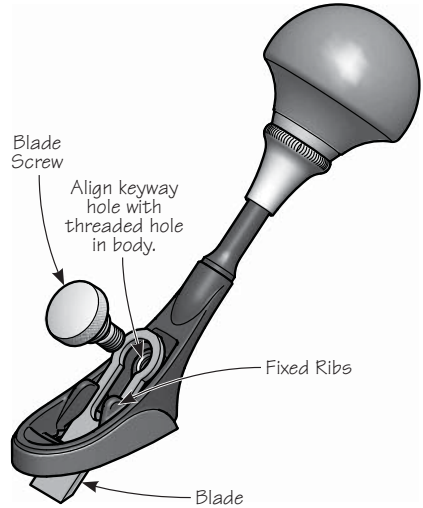

Figure 3: Blade installation.

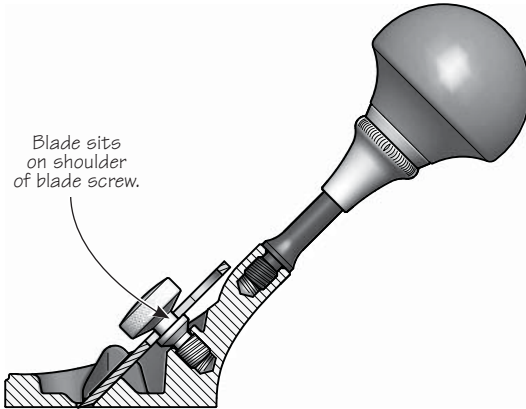

Figure 4: Blade clamping.

Sight down the sole of the plane. The blade edge of the flat plane should be parallel to the sole, and the blade edge of the curved planes should be evenly offset from the sole. Adjust as required.

To advance the blade, hold the plane firmly in one hand and tap the end of the blade with a small mallet or a plane hammer. To adjust the blade for even shaving thickness, tap either side of the blade until the edge is parallel to the sole for the flat plane, or evenly offset from the sole for the curved planes.

Blade Sharpening

The 0.060" thick by 3/8" wide A2 tool steel blades have the bevel ground at a 30° angle, and can be sharpened using most typical techniques.

The cutting edge of the curved blades is ground in a curve to match the sole of the plane, which translates into a 0.69" (11/16") radius on the bevel of the blade. Small slip stones will be required for the concave blade.

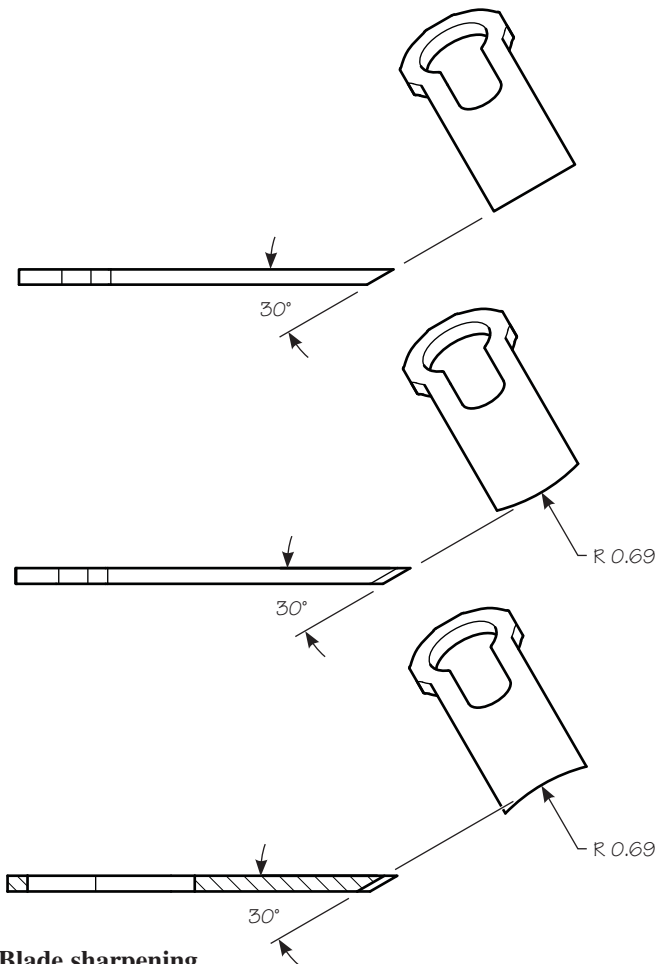

Figure 5: Blade sharpening.

Handle Adjustment

The length of the knob stem is adjustable over a $\frac{3}{8}$ " range so that the plane grip can be set for the user's comfort. As delivered, the knob should be set at about the center of its adjustment range. To change the setting, loosen the knob locking collar and turn the knob to the desired position. Once the knob is located at a comfortable working position, tighten the locking collar to secure everything in place.

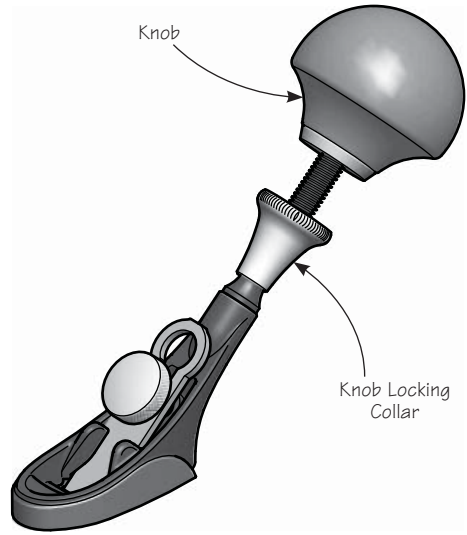

Figure 6: Adjusting the knob.

For additional user comfort, the stem/knob assembly can be removed, as shown in **Figure 2**.

If desired, you can fill the hole in the plane body with a short 10-32 screw or set screw to prevent debris from clogging it.

Care and Maintenance

The body of this plane is cast steel and comes treated with rust preventative. Remove this using a rag dampened with mineral spirits and clean all machined surfaces. We recommend that you initially, then periodically, apply a light coat of paste wax to seal out moisture and prevent rusting. Let wax dry, then buff with a clean soft cloth. To guard against dings and scratches, or if storage conditions are damp or humid, keep the plane wrapped in a cloth or stored in a plane sack.

Accessories

- 05P90.02** Straight Replacement Blade
- 05P90.03** Straight Toothed Blade
- 05P90.06** Convex/Double-Convex Replacement Blade
- 05P90.07** Convex Toothed Blade
- 05P90.14** Concave Replacement Blade

veritas® Tools Inc.

814 Proctor Avenue 1090 Morrison Drive
Ogdensburg NY 13669-2205 Ottawa ON K2H 1C2
United States Canada

customerservice@veritastools.com
www.veritastools.com